

## OWNER'S MANUAL

English

SERIES: "NAVIGATOR"

MODELS: N700

complete set: N700  
N700H\*

Design category (2003/44/EC): C  
ISO6185-3: Category VII

---

H\* – boat tube is made of HYPALON (Du Pont registered trademark) coated fabrics.

<b>CONTENTS:</b>	
DANGER LEVELS	5
INTRODUCTION	5
IDENTIFICATION PLATE	6
SAFETY REGULATIONS	7
BEAUFORT Wind Scale and Corresponding State of the Sea, After Few Hours of Wind, Away From the Coast.	8
Boat Design Categories	9
REMEMBER FIRE DANGER ALWAYS	9
TECHNICAL SPECIFICATIONS	10
COMPLETE SET	11
THE MAIN DIMENSIONS	13
BOAT DESIGN	14
POLYESTER HULL	17
REINFORCED BUOYANCY TUBE	18
S.S. ARC	19
POLYESTER STEERING CONSOLE	19
FUEL SYSTEM	21
DRAIN SYSTEM	22
Care & Maintenance of your Sunbrella® Fabric	24
WIRING DIAGRAM	25
PREPARATION FOR EXPLOITATION	26
INFLATION/DEFLATION BOAT TUBE	26
STORAGE BATTERY INSTALLATION	27
BOAT TRANSPORTATION BY TRAILER	27
HOW TO INSTALL SUNDECK	29
MAINTENANCE	30
OPERATING REGULATIONS	31



For your safety and for the validity of the guarantee expert and authorised personnel must install the motor and inspect and check the systems. All onboard systems must be completed and inspected.  
**CHECK, THAT THE CHECKS HAVE BEEN MADE AND THAT THE PLANTS HAVE BEEN COMPLETED BEFORE DELIVERY.**  
BRIG Ltd declines any responsibility for systems and accessories that have not been installed and checked by expert and authorised personnel.



The manual and all its enclosures should be stored carefully, and the manual should always be kept aboard. If the craft is resold, the manual and all its enclosures must be handed over to the new owner.

## **CE Certification and Main Features**

The CE marking indicates that the inflatable boat was built in compliance with the Directive 94/25/EC as amended by Directive 2003/44/EC applied to pleasure craft

### **Certifying Body:**



BUREAU VERITAS S.A.  
92077 Paris La Defense Cedex

### **Name of Manufacture:**

BRIG Ltd.  
Lozovskaya 88, Dergachy 62303  
Kharkovskaya obl.  
UKRAINE  
[www.brig.ua](http://www.brig.ua), [www.brig-ribs.com](http://www.brig-ribs.com)

## DANGER LEVELS.

The manual contains warnings, identified as follows:

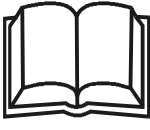
 <b>DANGER</b>	A note like this indicates that there is serious risk, that is likely to cause death or permanent serious injury, if appropriate precautions are not taken.
 <b>WARNING</b>	A note like this indicates the existence of risk that may cause death or injury, if appropriate precautions are not taken.
 <b>ATTENTION</b>	A note like this indicates reference to the application of safety or environmental protection practices, or draws attention to unsafe behaviour that might cause injury to persons or damage to the craft, its components or the environment.

## INTRODUCTION.

This manual was written to help you to use your boat safely. It contains information on the boat, its equipment (supplied or installed), operation and maintenance.









 <b>DANGER</b>	Before using your boat, read this MANUAL carefully and ensure that you have understood all the procedures it describes. Before taking command of your boat, be sure to have acquired experience and confidence in its operation.
--	--









**IDENTIFICATION PLATE.**

Builder's Plate:

**N700 with one engine**

**N700 with two engines**

  	
Notified Body No.0062 Conforms to ISO 6185	
Type <b>VII</b>	
MODEL <b>N700</b>	DESIGN CATEGORY <b>C</b>
 ≤ <b>166</b> kW <b>225</b> HP	 ≤ <b>12</b>
 +  +  ≤ <b>1800</b> kg <b>3968</b> lbs	
 0.15 bar (2.2 psi)	
Made in UKRAINE	

  	
Notified Body No.0062 Conforms to ISO 6185	
Type <b>VII</b>	
MODEL <b>N700</b>	DESIGN CATEGORY <b>C</b>
 ≤ <b>2x99</b> kW <b>2x135</b> HP	 ≤ <b>11</b>
 +  +  ≤ <b>1800</b> kg <b>3968</b> lbs	
 0.15 bar (2.2 psi)	
Made in UKRAINE	

Maximum propulsion power rating for the boat

The rated tube pressure value

Boat Design Categories according to Directive 2003/44/EC

Passengers capacity

Maximum load capacity (ISO method)

Plate with identification number:

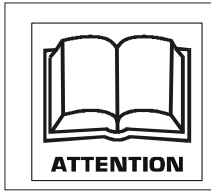

**UA-QRK12345A000**



It is fundamental for the plates to be aboard the boat, since they are only form of recognition and identification. Without them the boat does not comply with the legislation in effect. The plates must never be removed. Any tampering or removal not authorised by the manufacturer is the full responsibility of the owner.

## SAFETY REGULATIONS.

This manual contains recommendations and basic rules of conduct for using the boat in complete safety. Although it is not possible to offer safety information for all potential situations, in general it is recommended that you :

	Regularly check which safety requirements are in force.
	Maintain the boat and the onboard plants in optimum condition.
	Have the boat inspected by the dealer where it was purchased or by an authorised mechanic <b>at least once every year</b> for your own safety and for maintaining the guarantee.
	Always check weather and seagoing conditions before setting out. <b>For safe navigation, compare the design category of your boat with the table below.</b>
	When the tank is installed by the yard, the plant is prepared with a ground plait. The installation of the motor <b>MUST FORESEE A PLAINT CONNECTION</b> to the boat ground plait. Failure to connect (or failed maintenance) can result in the tank perforating leading to a serious risk of fire / explosion caused by leaking fuel.
	<b>Max number of transportable persones</b> is referred to an established weight of 75 kg per person (ISO 6185), so always make reference to total maximum transportable weight. <b>The max weight of the installable motors</b> indicates the maximum overall weight applicable on the stern board, including any emergency motors. <b>NEVER exceed the stated value.</b>

**BEAUFORT Wind Scale and Corresponding State of the Sea, After Few Hours of Wind, Away From the Coast.**

Force	Denomination	Knots	Km/h	m/sec	State of the sea and wave height in meters	
0	Calm	<1	<1	0-0.2	Calm	0
1	Light Air	1-3	1-5	0.3-1.5	Calm	0
2	Light Breeze	4-6	6-11	1.6-3.3	Almost calm	0.2
3	Gentle Breeze	7-10	12-19	3.4-5.4	Almost calm	0.2
4	Moderate Breeze	11-16	20-28	5.5-7.9	Small waves	0.5
5	Strong Breeze	17-21	29-38	8.0-10.7	Large waves	1.25
6	Fresh Wind	22-27	39-49	10.8-13.8	Large waves	2.0
7	Strong Wind	28-33	50-61	13.9-17.1	Very large waves	2.5
8	Gale	34-40	62-74	17.2-20.7	Rough sea	4
9	Strong Gale	41-47	75-88	20.8-24.4	Very rough sea	6
10	Storm	48-55	89-102	24.5-28.4	Heavy	9
11	Violent Storm	56-63	103-117	28.5-32.6	Very heavy	14
12	Hurricane	64 and over	118 and over	32.7 and over	Stormy	14 and over

**Boat Design Categories (Directive 2003/44/EC):**

Design category	Wind force (Beaufort scale)	Significant wave height
"A" - "Ocean"	exceeding 8	exceeding 4
"B"- "Offshore"	up to, and including, 8	up to, and including, 4
"C"- "Inshore"	up to, and including, 6	up to, and including, 2
"D"- "Sheltered waters"	up to, and including, 4	up to, and including, 0.3

NOTE: **The significant wave height** is the mean height of the highest one-third of the waves, which approximately corresponds to the wave height estimated by an experienced observer. Some waves will be double this height.





**ALWAYS REMEMBER ABOUT FIRE DANGER.**

**Fire may be caused by:**

Crew negligence when smoking, the presence aboard of flammable liquids, electrical contacts, propulsion motor, errors in fueling, or if maintenance has not been performed as required.

Once again, it is important that the crew behave correctly and that the boat is kept in order to avoid serious damage to it and to persons.

 <p><b>WARNING</b></p>	Easily flammable products must not be kept aboard.
---	--

 <p><b>DANGER</b></p>	<b>BATTERY:</b> the battery may cause sparks or explosions. It must be stored in an appropriate container, easily reached and well aired, <b>AWAY FROM FUEL OR INFLAMMABLE PRODUCTS.</b> Periodically check that the clips are tight and protect them with appropriate insulation in order to prevent sparks or the spread of current.
--	--

However, if a fire does occur aboard, stop motor, disconnect the batteries immediately, check to see if it is an electrical component or any case a small-scale fire that does not involve flammable liquids, in which case use a suitable fire extinguisher to try and put the fire out completely.

 <p><b>WARNING</b></p>	Extinguisher or any other fire-fighting equipment must not be kept in compartments with key lock, but in easily accessible and clearly indicated locations.
	Extinguisher or any other fire-fighting equipment should be checked periodically and replaced with the same or superior types <b>if expired or inefficient.</b>

 <p><b>DANGER</b></p>	Equip the boat with fire-fighting equipment before launch and use.
--	--

## TECHNICAL SPECIFICATIONS.

The basic parameters and dimensions of the "NAVIGATOR" boats N700 (N700H) comply with the data specified in the following table. All dimensions measurements indicated have a tolerance of +/- 3%, weight measurements indicated have a tolerance of +/- 5%.

Parameter	N700 (with one engine)	N700 (twin engines)
Length (without engine)	6.99 m	6.99 m
Width	2.8 m	2.8 m
Height	2.08m	2.08m
Inflatable tube diameter, max.	0.58 m	0.58 m
Cockpit dimensions:		
- length	5.05 m	5.05 m
- width	1.59 m	1.59 m
Deadrise angle on transom	21°	21°
Deadrise angle in middle section	24°	24°
Transom height	615mm	615mm
Number of independent air-tight chambers	5	5
Nominal pressure	0.15 bar / 2.2 psi	0.15 bar / 2.2 psi
Passengers capacity	12	11
Recommended engine power	200HP / 148kW	2x120HP / 2x89kW
Maximum engine power*	225HP / 166kW	2x135HP / 2x99.3kW
Maximum engine weight	290kg	2x200kg
Engine shaft length	25" (Extra Long)	20" (Long)
Built-in fuel tank capacity	340L	340L
Weight of empty boat (without: steering console, arc, driver seat, fuel, engine)	700kg	700kg
Weight of boat with equipments (with steering console, with S.S.arc, with driver seat, without engine, without fuel)	920kg	920kg
Maximum load capacity of empty boat(ISO method)	1800kg	1800kg
Displacement in Light Craft Condition (LCC)	1230kg	1340kg
Maximum total load (ML)	1270kg	1160kg
Maximum transportable mass	1600kg	1675kg
Loaded displacement mass	2500kg	2500kg

\* When the boat is fitted with an engine with maximum recommended power it must be use with extreme care. This application is directed at experienced users using their boats for very specific purposes.

**COMPLETE SET .**

In the table is shown the maximum possible complete set, which may differ from your boat.

No	Description	Unit of measure	N700, N700H
1	<b>Inflatable boat</b>	pcs.	1
2	<b>Foot pump</b>	pcs.	1
3	<b>Paddle</b>	pcs.	2
	<b><i>Set of spare parts and repair kit:</i></b>		
4	- mooring line	m	18
5	- coated fabric for repair	m <sup>2</sup>	0.06
6	- glue set for repair	set	1
7	<b>Bag</b>	pcs.	1
8	<b>Owner's manual</b>	pcs.	1
9	<b>Built-in fuel tank</b>	pcs	1 (340L)
10	<b>Steering console with installation kit</b>	pcs.	1
	<b><i>Steering console equipment:</i></b>		
11	Hydraulic steering system	set	1
12	Steering wheel	pcs.	1
13	Fuel level clock	pcs.	1
14	Switches of electrical equipment	pcs.	5
15	Socket 12V with fuse	pcs.	1
16	Compass	pcs.	1
17	Speedometer	pcs.	1
18	Tachometer	pcs.	1
19	Electric horn	pcs.	1
20	<b>Front locker removable cushion</b>	pcs.	1
21	<b>Composed driver seat/bolster with installation kit</b>	pcs.	1
22	<b>Jockey seat with installation kit</b>	pcs.	4 (variant)

No	Description	Unit of measure	N700, N700H
23	<b>Stainless steel arc with installation kit</b>	pcs.	1
	<b>Arc equipment:</b>		
24	Anchor light (white)	pcs.	1
	<b>Running lights:</b>		
25	Port (red)	pcs.	1
26	Starboard (green)	pcs.	1
27	<b>Drain automatic bilge pump</b>	pcs.	1
28	<b>Towing eye</b>	pcs.	1
29	<b>Soft back of stern-part seat</b>	pcs.	1
	<b>Additional options:</b>		
30	Bow sun deck set with cushions	pcs.	1
31	Overall cover	set	1
32	Steering console/seats cover	set	1
33	Foldable S.S. ladder	pcs.	1
34	Collapsible sun-top	set	1
35	Battery container	pcs.	1
36	Valve cap pressure gauge	pcs.	1
37	Shower kit (water tank 45 litres, shower pump and handset)	set	1

**Note.** Perfection of the design and improvement of quality of our products is the fundamental production policy of our company. Therefore, alternations may be made to the complete set (and as the components become available).

## THE MAIN DIMENSIONS.

The main dimensions of N700 have tolerance of +/- 3%.

The length of the boat with the engine can vary depending on the model of the engine and the angle of its deviation. (See Fig. D0)

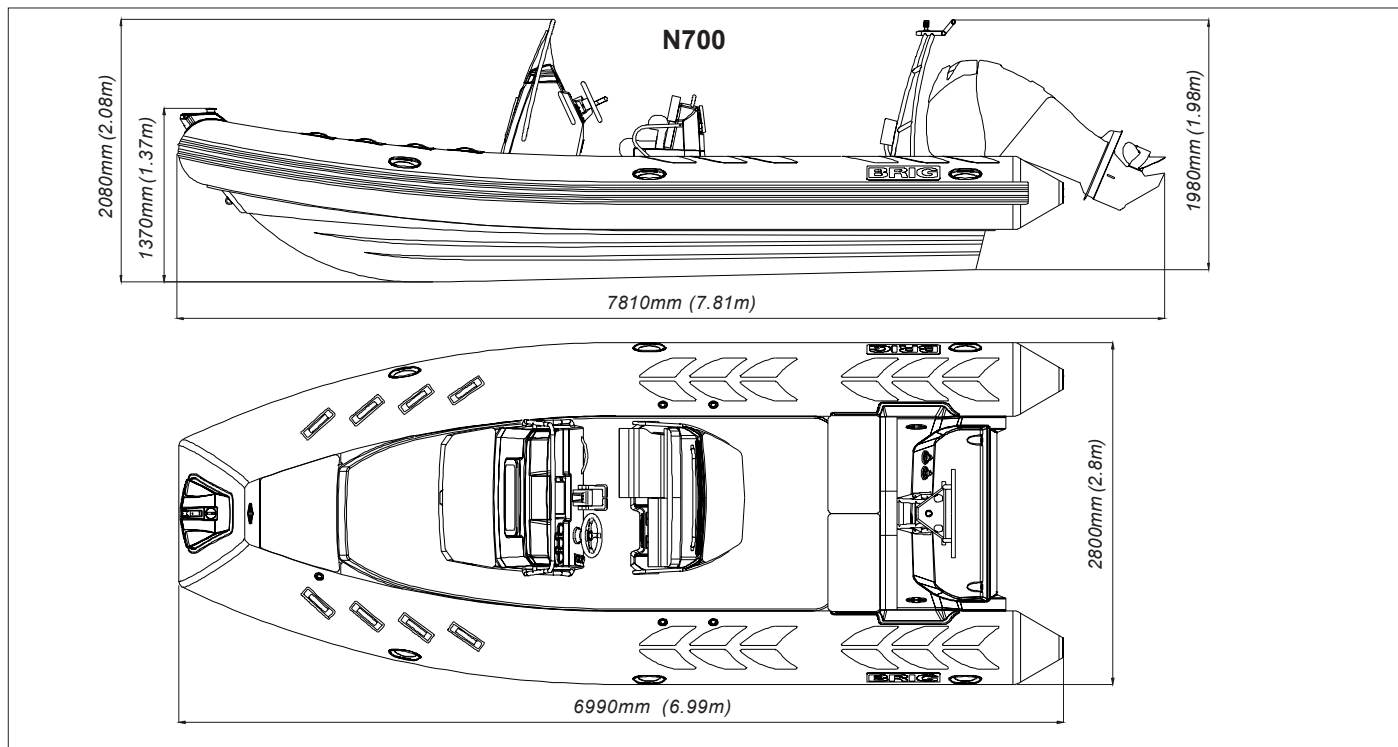

D0

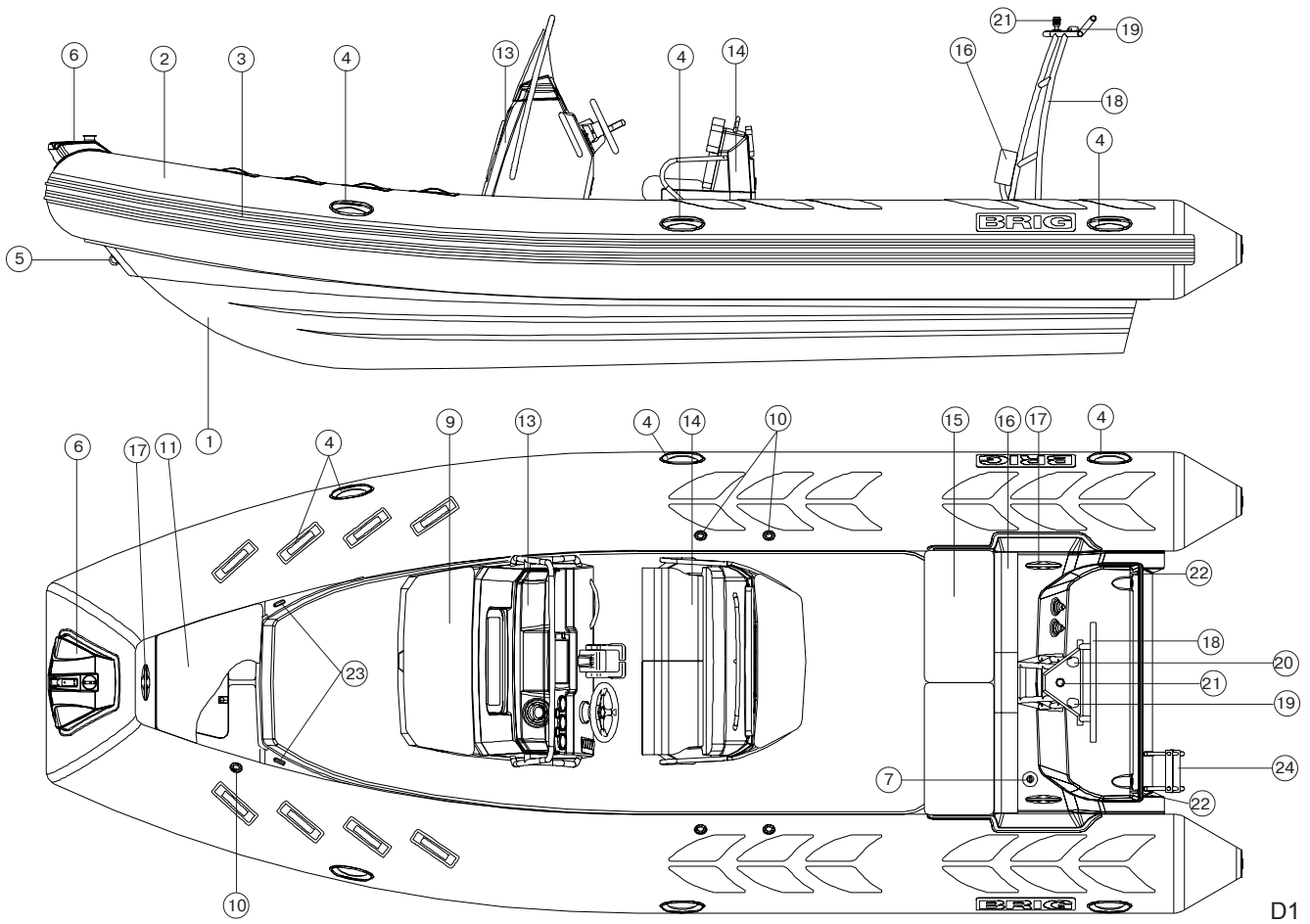

D1

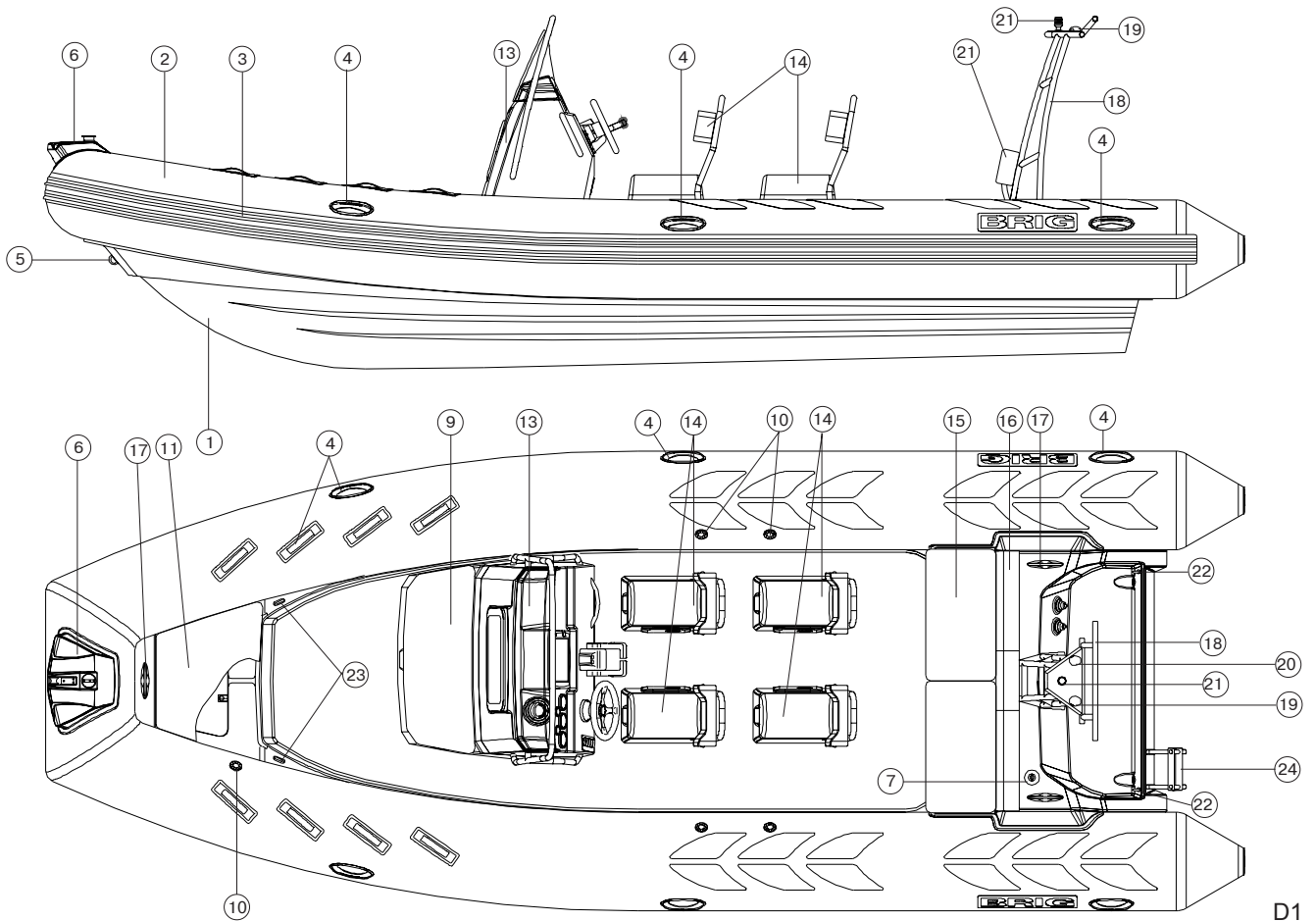

D1

## BOAT DESIGN.

The boat series "NAVIGATOR" N700 consists of the next main components (Fig. D1):

- polyester hull (1);
- reinforced buoyancy tube (2);
- polyester steering console (13);
- composed driver seat/bolster or jockey seats (14);
- stainless steel arc (18).

### ●DESCRIPTION:

- 1 — Polyester hull.
- 2 — Reinforced buoyancy tube.
- 3 — Doubled rubbing strake.
- 4 — Safety handles.
- 5 — Towing bow eye.
- 6 — Bow step-plate with bow roller.
- 7 — Neck for fuel fill.
- 9 — Steering console seat.
- 10 — Air fill valves (5 pcs.).
- 11 — Front locker removable cushion.
- 12 — Cockpit drain system sockets (2 pcs.).
- 13 — Steering console.
- 14 — Composed driver seat/bolster or Jockey seats (4 pcs.).
- 15 — Stern-part seat.
- 16 — Soft backs of stern-part seat (3pcs.).
- 17 — Mooring cleats (3pcs.).
- 18 — Stainless steel arc.
- 19 — Port running light (red).
- 20 — Starboard running light (green).
- 21 — Anchor light (white).
- 22 — Stern lifting eyes.
- 23 — Bow lifting eyes.
- 24 — Foldable stainless steel ladder.

D1

— 16 —

"BRIG" inflatable boats

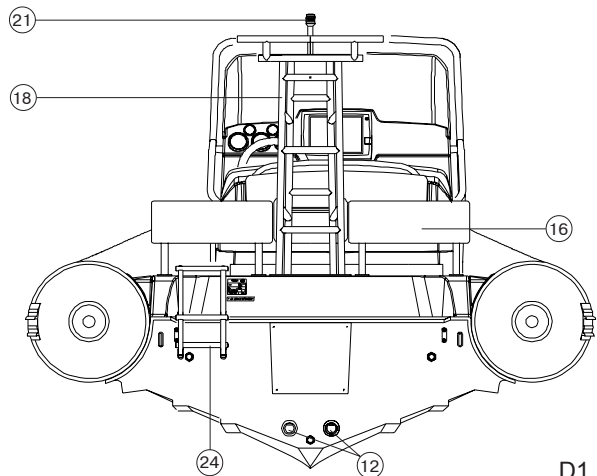
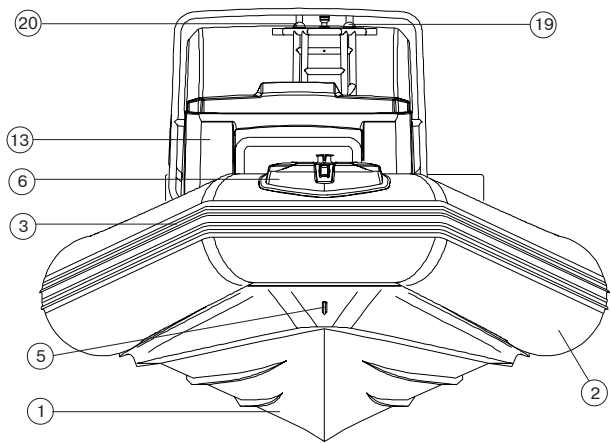



●POLYESTER HULL.

The boat hull has "deep-V" shaped bottom with four longitudinal steps. The upper deck has a special moulded antiskid coating. There is two specified sections (Fig. D2):

- bow locker (1) is intended for arrangement of anchor and anchor rope or for baggage arrangement;
- stern compartment (2).

The bow locker have a direct access by hinge out the access door (18).

Onto the access door of the bow locker there is a removable soft cushion (11, Fig. D1). Onto the stern compartment there is soft seat (15, Fig. D1) and soft back (16, Fig. D1).

The boat hull is arranged with the following components:

- bow towing eye (5, Fig.D2a);
- fuel tank (3, Fig.D2);
- battery disconnecter (6, Fig. D2b);
- cockpit drain system sockets (7, Fig. D2b, D2d);
- two stern lifting eyes (9, Fig. D2c);
- drain out of motor recess (10, Fig. D2c);
- drain automatic bilge pump (11, Fig. D2d);
- two bow lifting eyes (14, Fig.D2);
- outer neck for fuel fill (13, Fig.D2);
- inspection hatch (12, Fig.D2);
- one bow and two stern cleats (17, Fig.D2);

The fore part of the cockpit may be simply converted into the sundeck by means of false decks and soft cushions.

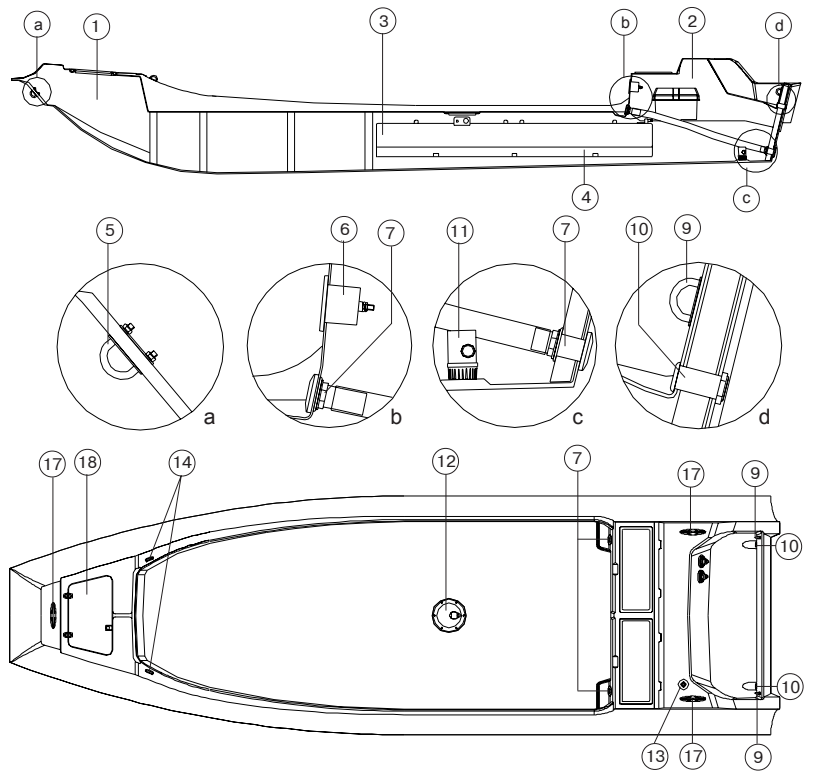

D2

## ●REINFORCED BUOYANCY TUBE.

The boat buoyancy tube has U-shaped form. The tube is separated by means of inner elastic partitions into five chambers of a similar volume, each being provided with an air fill valve.

The air fill valve is intended for:

- filling the compartment with air from a standard pump or filling system and maintaining pressure in the tube for prolonged time,
- adjustable drop of pressure in compartment.

The air fill valve is designed as a tab-type non-return valve and consists of the following components (Fig. D3):

- housing (1);
- cup (2) with strap (3);
- washer with gasket (4);
- nut (5);
- spindle (6) with spring (7) and cup diaphragm (8).

Also there are the following elements fitted on the tube (Fig. D1):

- doubled rubbing strake (3, Fig.D1);
- safety handles (4, Fig.D1);
- bow step-plate with a special moulded antiskid coating (6, Fig.D1).

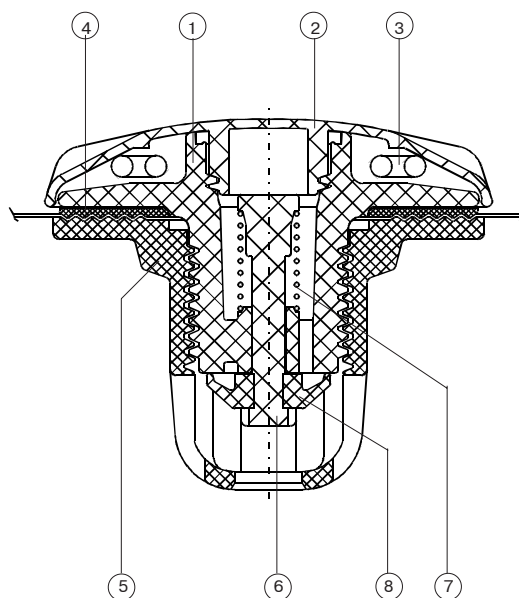

D3

●**STAINLESS STEEL ARC.**

Stainless steel arc (18, Fig.D1) is located in the stern part of the boat.

Arc is equipped with anchor light (white, 21) and running lights: port (red, 19) and starboard (green, 20), (Fig. D1).

●**POLYESTER STEERING CONSOLE.**

Steering console is located in the central part of the boat. The console consists of the following components (Fig. D4):

- console base (1);
- console upper part (2);
- windscreen (3);
- stainless steel railing (4);
- front soft seat (5);
- console recess (7);
- special place for installation of analog or/and digital devices, such as speedometer, tachometer, trim-meter, fuel-level meter, multipurpose meters, GPSmap, etc. (8);
- footstep (9);
- hatch in the front of the upper part of the console with soft cushion;
- electric horn (on the right side of the upper part of the console).

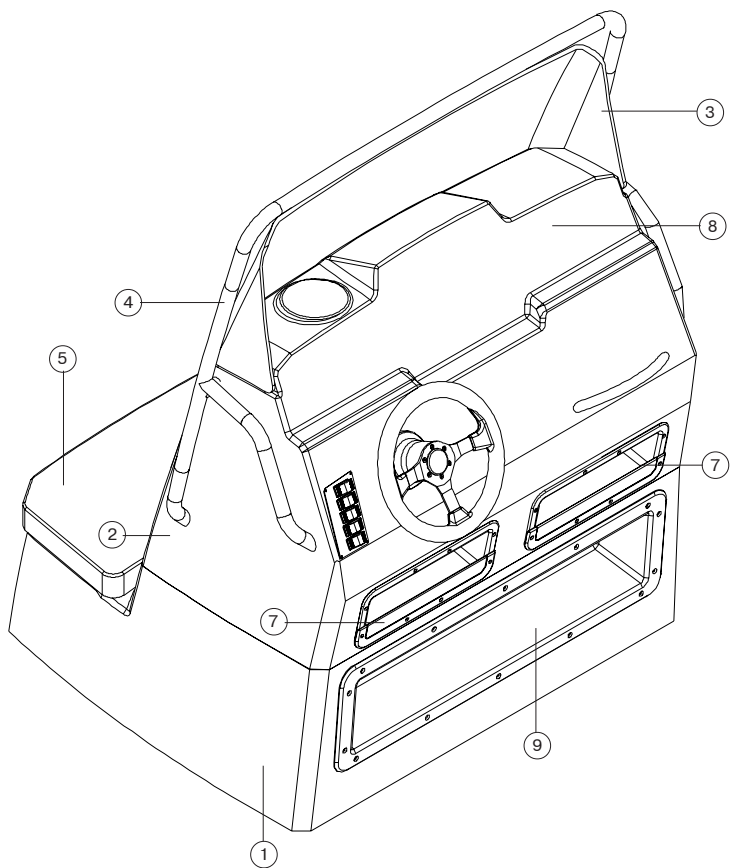

**Console equipment** (Fig. D5):

- hydraulic steering system;
- steering wheel (1);
- compass (2);
- fuel-level meter;
- speedometer;
- additional equipment (tachometer or multi-purpose meter, trimmer, voltmeter, clock);
- socket 12V with fuse (3);
- fuse holding box with warning lights (inside of the steering console)
- switches:
  - electric horn switch (4);
  - anchor light switch (5);
  - running lights and meter lamp switch (6);
  - bilge pump switch (7);
  - shower switch (8);

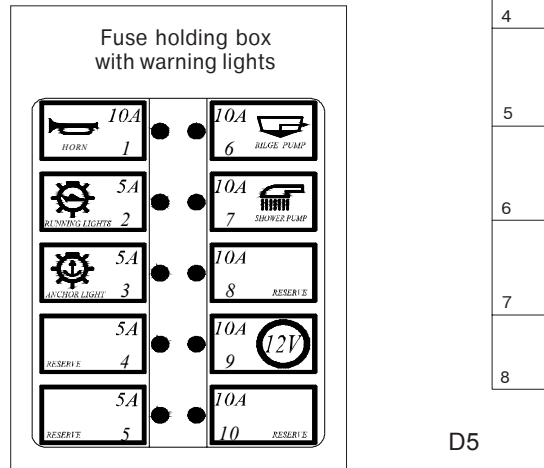
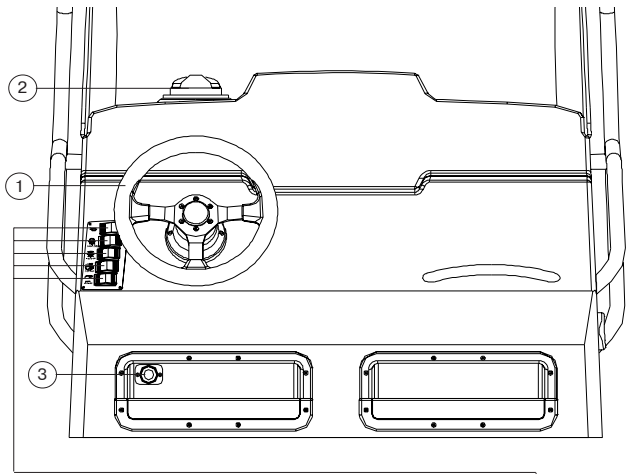

	<p>Always check the fuse. Burning red LED display on the fuse box warns of faulty fuse</p>
--	--

	<p>Always keep a spare set the fuse in an easily-accessible location.</p>
--	---

●FUEL SYSTEM.

Fuel system consists of the following components (Fig. D6):

- built-in fuel tank (1);
- electric fuel gauge (2);
- outer neck for fuel fill (3);
- fuel hose (from outer neck for fuel fill to fuel tank) (4);
- fuel hose (from fuel tank to outboard motor) (5);
- fuel venting hose (6).

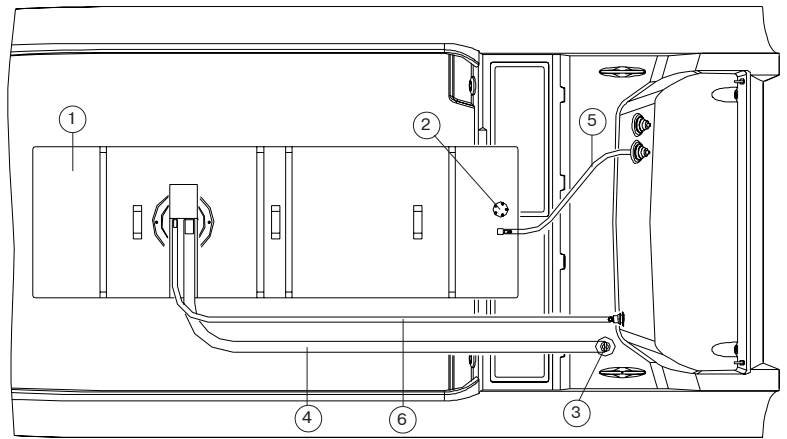

D6

 <b>DANGER</b>	Pre-filter and fuel valve must be installed by authorized representative specialists only.
	Do not modify fuel system. Any modification, repair and planned maintenance of the fuel system may be made by authorized representative specialists only.
	Check that there are no leaks in the fuel systems

 <b>WARNING</b>	Do not smoke when refueling. Stop the engine and switch off any electric equipments before refueling.
	It is dangerous to pretend to be an expert. This may cause damages. Refer to expert and authorized specialists for all types of maintenance and repair.

## ●DRAIN SYSTEM.

Drain system, (Fig. D7, D8 ), consists from two independent systems:

- cockpit and motor recess drain system;
- hull drain system.

*COCKPIT AND MOTOR RECESS DRAIN SYSTEM includes:*

- two cockpit drain sockets (1);
- two stern drain sockets with flexible diaphragms (2);
- two drain hoses (3);
- drain socket thru-hull out of motor recess (4);

*HULL DRAIN SYSTEM includes:*

- automatic bilge pump (5);
- drain hose (6);
- drain socket installed in the motor recess (7);
- bilge drain socket (8) (Fig.D8).

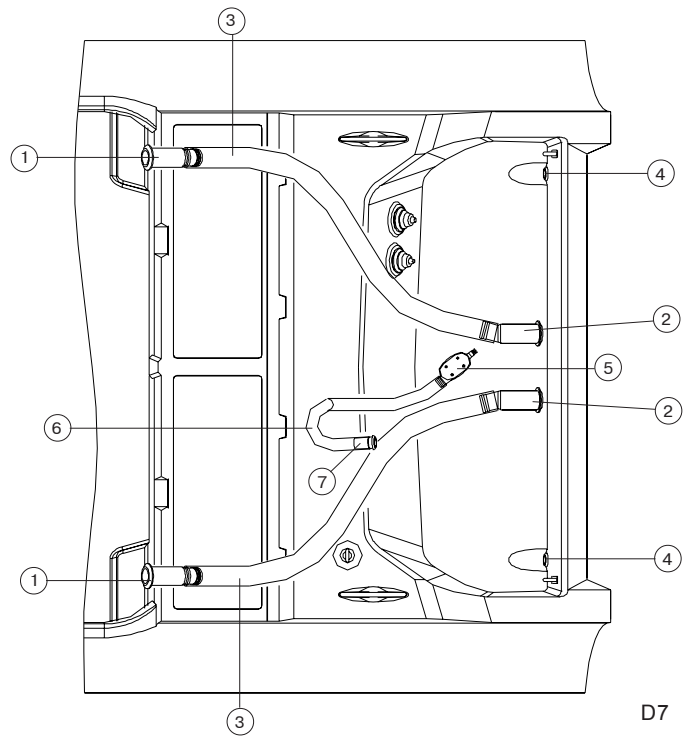



D7

	Always the cockpit drain sockets must be open during navigation. Do not obstruct cockpit drain sockets at any time. Do not dispose bulky objects in front of the cockpit drain sockets.
	Do not modify drain systems. Before navigation check the drain valves.
	Never locate heavy objects on the drain hoses. It will be cause of bucking, distortions and damages.

 <p><b>WARNING</b></p>	<p>Bilge valve (8)(Fig.D8) should be tightly CLOSED when the boat on the water</p> <p>Bilge valve (8)(Fig.D8) should be open when the boat is out of the water</p>
---	--

 <p><b>WARNING</b></p>	<p>It is dangerous to pretend to be an expert. This may cause damages. Refer to expert and authorized specialists for all types of maintenance and repair.</p>
---	--

 <p><b>WARNING</b></p>	<p>Always the cockpit drain sockets must be open during navigation. Do not obstruct cockpit drain sockets at any time. Do not dispose bulky objects in front of the cockpit drain sockets.</p>
---	--

 <p><b>WARNING</b></p>	<p>Do not modify drain systems. Before navigation check the drain valves.</p>
---	---

 <p><b>WARNING</b></p>	<p>Never locate heavy objects on the drain hoses. It will be cause of bucking, distortions and damages.</p>
--	---

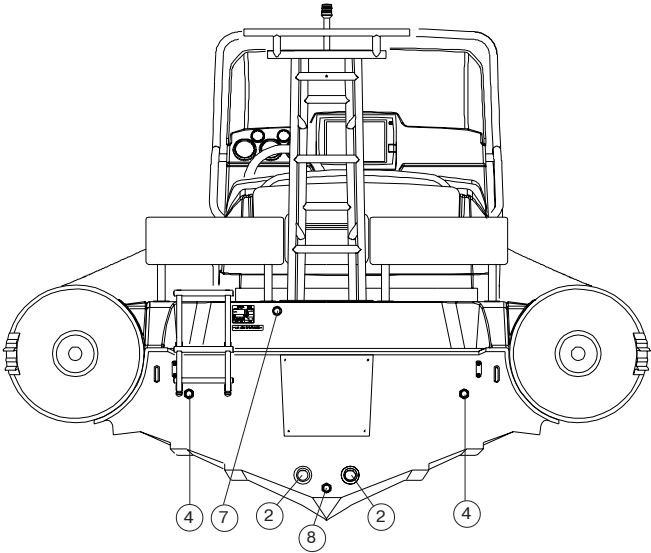

D8

## Care & Maintenance of your Sunbrella® Fabric

If soft seats and cushions of your BRIG boat are made from Sunbrella® fabric, please read this instruction for the proper care of fabric.

Sunbrella® fabrics are made from solution-dyed acrylic fibres specifically designed for outdoor use. These air-permeable fabrics are chemically treated during manufacture. The treated fabric is more resistant to water, soiling (watermarks, dirt resulting from pollution or oily substances) and to the formation of mildew.

Over time, the effectiveness of the treatment diminishes. We therefore recommend that you clean and re-treat your fabric regularly in order to keep it in excellent condition and to make it last much longer.

### Cleaning

- 1) When dry, brush the fabric (using a clothes brush or similar) in order to remove as much dirt as possible.
- 2) Spray the fabric with a jet of water, to moisten it.
- 3) Prepare a cleaning solution as follows:
  - For a standard clean: add 100ml (or more) of mild soap to 4 litres of hot water (maximum 40°C)
  - For the best possible result: use **303 Fabric Cleaner**
- 4) Brush the fabric using a soft brush (clothes brush or similar) and leave the solution to act for a few seconds.
  - **To remove marks:** use the cleaner on its own, or just slightly diluted with water. Spray onto the mark until the fabric is wet. Work the product in using a soft brush. Wipe away the mark and any excess cleaner with a wet cloth.
- 5) Rinse thoroughly with clean water.
- 6) Leave the fabric to dry in the open air.

**Note:** to avoid any deterioration of the fabric, we recommend you never expose it to sources of heat (e.g. hair dryers) or never use the following when cleaning: detergent, hot water (above 40°C), high-pressure cleaners.

### Protection

**303 High Tech Fabric Guard** restores your fabric's original water-resistant and dirt-repellent properties. It stops leaks, prevents the formation of marks and mildew and protects the fabric against the harmful effects of UV rays.

Re-treating with **303 High Tech Fabric Guard** is easy, quick and produces long-lasting results.

- Use only on completely dry, new or recently cleaned fabric.
- Spray **303 High Tech Fabric Guard** until the fabric is moist.

#### Do not overspray.

- Leave the fabric to dry completely before using it or putting it away.

If you have the time, give your fabric a second treatment. Leave it to dry completely in the open air between treatments.

Coverage: use 500 ml for every 7 to 10 square metres treated.

**Note:** the use of silicone-based waterproofing products is not recommended. They are not compatible and there is therefore a risk of marks appearing once exposed to the air. Waterproofing products designed for use with wood and brickwork are also not recommended.

Read the instructions and recommendations on the label before using **303 HighTech Fabric Guard** and **303 Fabric Cleaner**.



●WIRING DIAGRAM.

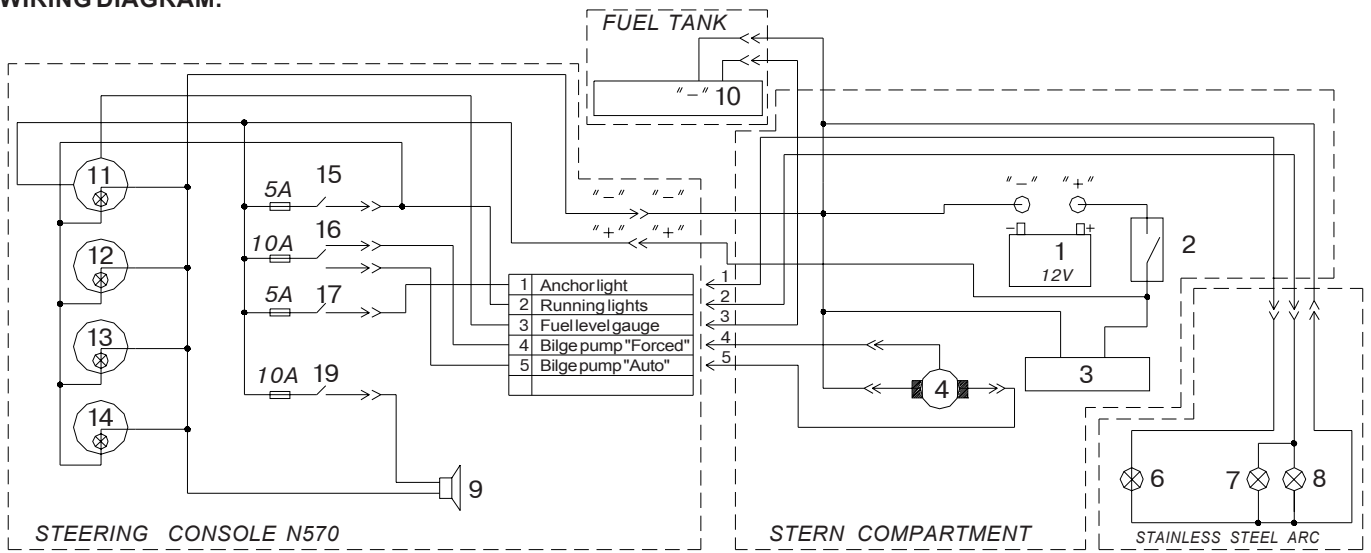

D9

DESCRIPTION:

- |   |  |
|---|--|
| 1 — Battery (is not included to the complete set).        | 12 — Tachometer.   |
| 2 — Battery disconnecter.                                 | 13 — Compass.  |
| 3 — Outboard motor (is not included to the complete set). | 14 — Speedometer.  |
| 4 — Bilge pump.   | 15 — Switch with automatic circuit breaker — meter lamp and running lights switch. |
| 6 — Anchor light (white).                                 | 16 — Switch with automatic circuit breaker — bilge pump "FORCED" / "AUTO"          |
| 7 — Port light (red).                                     | 17 — Switch with automatic circuit breaker — anchor light (white).                 |
| 8 — Starboard light (green).                              | 19 — Switch with automatic circuit breaker — electric horn.                        |
| 9 — Electric horn.  |  |
| 10 — Fuel level gauge.                                    |  |
| 11 — Fuel level meter                                     |  |

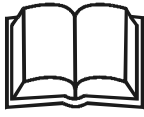
 <b>WARNING</b>	<p>Do not modify electrics of the boat. Any modification, repair and planned maintenance may be made by authorized representative specialists only.</p>	 <b>ATTENTION</b>	<p>When leaving the boat, remember to disconnect the batteries.</p>
	<p>Do not touch the electrical equipment with wet hands.</p>		

**PREPARATION FOR EXPLOITATION.**

In order to set the boat in the operation condition perform as follows:

- unfold the inflatable tube;
- mount the outboard motor on the transom in accordance with its own installation instruction (manual of your outboard engine).

**●INFLATION/DEFLATION OF THE BOAT TUBE.**

The inflatable tube of the boat has five independent air-tight chambers. Before inflation it's necessary to set all valves in operating condition. In order to switch valve in operating condition, please press spindle 6 (Fig. D3) with your finger and rotate it clockwise until the spindle will be fixed. If this operation isn't possible, it means the valve already has been set in operating condition.

Fill the tube with air using the pump from the complete set. First fill two rear chambers, next two middle chambers. However, do not increase the pressure up to its operating value (the tube will be completely straightened). After that, please fill the fore chamber up to the rated pressure. **The rated pressure value is 0.15 bar (2.2 psi).** Having completed filling, close the valve covers.

In order to discharge air from the tube chambers, open the valves (please press spindle 6 (Fig. D3) with your finger and rotate it anticlockwise until the spindle will be fixed).

 <b>WARNING</b>	<p>Do not use compressors and/or other types of inflating equipments not approved by the boat builder.</p>
	<p>Check the tube pressure before every navigation.</p>
	<p><b>The rated pressure value is 0.15 bar (2.2 psi).</b> If the tube pressure more than nominal, deflate the tube slightly. Boat exploitation with board pressure more than nominal decreases boat service life.</p>



Board air chambers are hermetical if they keep own form during 8 hours. In this case:

- primary pressure has to be nominal;
- input valves openings have to be tightly closed by caps.

### ●STORAGE BATTERY INSTALLATION.

In order to install the storage battery, perform next operations:

- open door of the stern compartment;
- install the storage battery into the battery container;
- connect the battery terminals with motor battery cord and battery disconnecter;
- please, check efficiency of the electric equipment.



Before installation your storage battery read the BATTERY MANUAL carefully and ensure that you have understood all the described procedures.

### BOAT TRANSPORTATION BY TRAILER.

Installed on a trailer (or on keel-blocks for storage) the boat should be laying on all surface of the Main loading area (keel line) (see Fig. D10).

It is possible to install the boat on several reference points. Thereby the point of support (1) must be an obligatory, and the point of support (2), (3), (4) must be an additional.

Lateral roller supports can be used only with a view of prevention from tipping.

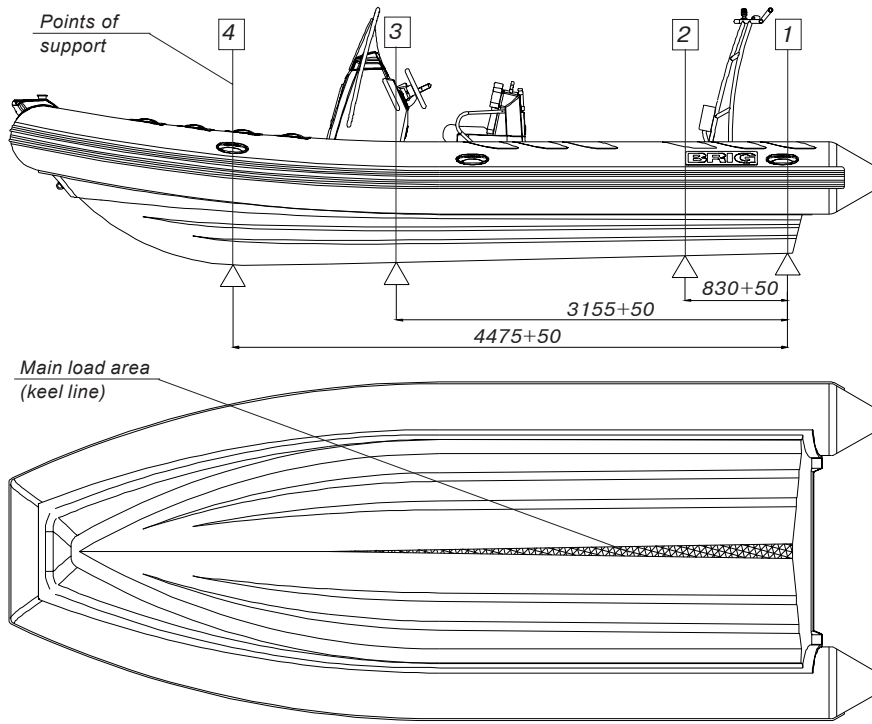

D10

 <b>ATTENTION</b>	<p><b>Maximum transportable mass</b>  <b>N700 with one engine – 1600 kg</b>  <b>N700 twin engines – 1675 kg</b></p>
---	---

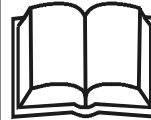
 <b>ATTENTION</b>	<p>In order to avoid the hull damage, install the boat on the stated areas only.</p>
---	--

●HOW TO INSTALL SUNDECK.

Sundeck set includes two false deck boards and two soft cushions. In order to install the sundeck (Fig. A1), please do the next:

- Open front seat of the steering console (Fig. A1a).
- Put false deck boards into the special drops in the front wall of the cockpit and the front wall of the console, (Fig. A1b).
- Close the front seat of the steering console (Fig. A1c).
- Further, please place two soft cushions onto the false decks and fasten them with the help of press-buttons (Fig. A1d).

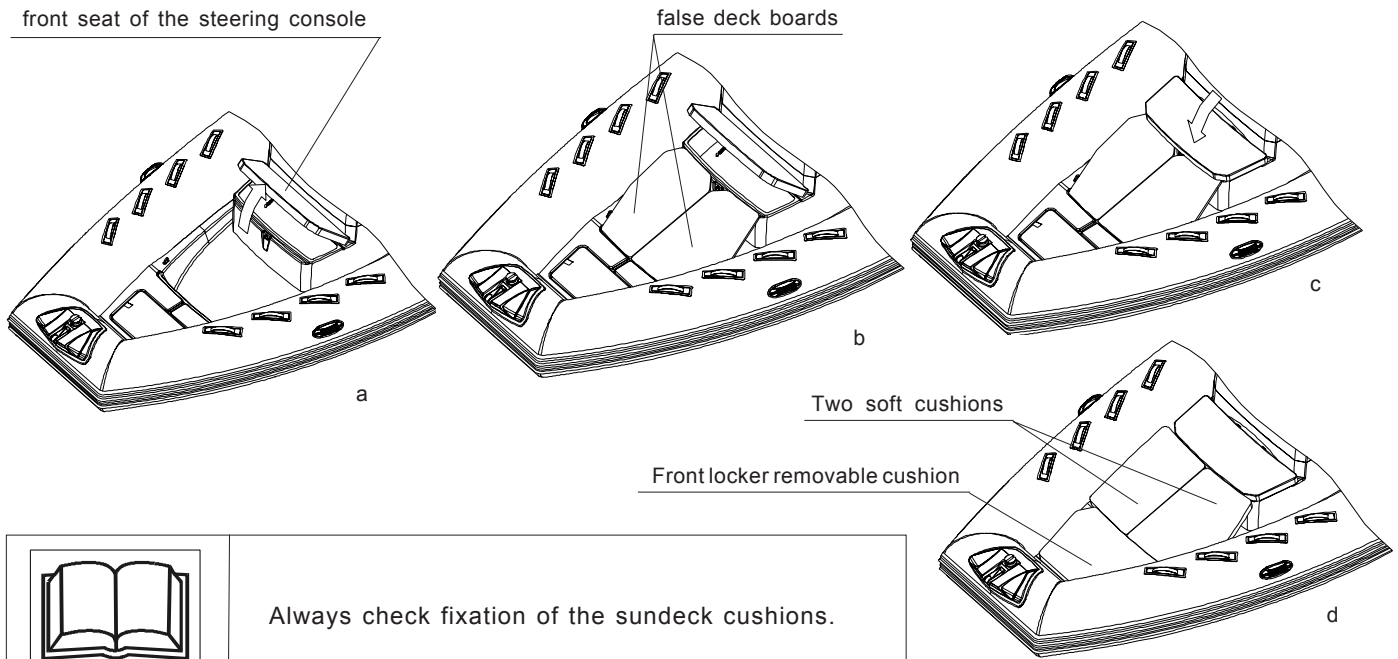

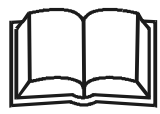
 <p><b>ATTENTION</b></p>	<p>Always check fixation of the sundeck cushions.</p>
---	---

## MAINTENANCE.

- Main conditions of long service life is right and careful servicing. Avoid excessive increasing of pressure in the board, especially from heating by the sun rays.
- At the end of exploitation take off sand and dirt from boat surface, and carefully dry it.
- Avoid the water getting into the chambers. If a fuel or an oil gets to the boat surface it is necessary to wash the soiled place by soap water as soon as possible and dry.
- Pay attention to the condition of bottom surfaces. If the cover is destroyed it is necessary to dry this element and restore the defend cover.
- At the end of the season exploitation, prepare the boat to winter keeping. Clean boat surface from sand and dirt, and make the necessary repairs, if damages take place. If it is possible, keep the boat in open and slightly pumped state at air temperature 0-25°C. The boat must be protected from the sun rays.
- Insignificant boat repairing (eliminating the board punctures or cuts) you may carry out by yourself. In this case use the coated fabric and glue set for repair from the complete set.

The own fulfilment of any complex repair associated with considerable damages to the board, partitions and seams is not recommended. In such cases, apply to your dealer.

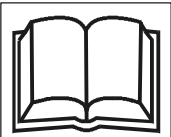

**ATTENTION**





Storage of the boat with temperature variations from -30°C to +45°C may be allowed not longer than 1 month. In case the boat has been stored or transported at a temperature below 0°C, it must be kept at a temperature above +15°C at least for 1 hour before to be unpacked and unfolded.





For small repair boat tube use the coated fabric and glue set from the complete set.

**OPERATING REGULATIONS.**

Dear user,

We thank you for your purchase and do hope that you will have a great fun of it. However, to make your joy and pleasure complete, we would request you to read carefully and observe the directions and recommendations specified below.

 <p><b>DANGER</b></p>	<p>IT IS STRICTLY FORBIDDEN to handle the boat in the state of intoxication and without individual rescue means being used (life-saving belts, jackets, etc.)</p>
	<p>IT IS FORBIDDEN to use an outboard motor of power exceeding the maximum allowable value</p>
 <p><b>WARNING</b></p>	<p>IT IS FORBIDDEN to bring the tube pressure up to the value exceeding the rated one <b>(0.15 bar(2.2psi))</b></p>
	<p>IT IS STRICTLY FORBIDDEN to drag the boat across a rough surface.</p>
	<p>For each particular water area the local shipping regulations are in force. You may apply for information to the appropriate water transport and shipping directorate, as well as to the water police.</p>
 <p><b>WARNING</b></p>	<p>Use the boat equipment and accessories only on their direct purpose to ensure reliable service.</p>
	<p>Even when sailing with an outboard engine you should always have the oars available with you so that you were able to reach the shore without outside assistance in case of any damage of the boat.</p>
 <p><b>WARNING</b></p>	<p>On your request any outboard engine seller may provide your engine with the emergency stop switch. During navigation the switch should be connected to the wrist of your hand by means of a cord. In case you fall overboard, even if being a steersman, the switch will cut out the engine and the propeller. This arrangement will enable you to avoid any traumas and to reach the boat.</p>
	<p>Take all possible precautions against penetration of fuel, oil or electrolyte from the storage battery into the inflatable boat. If it does happen wash thoroughly the fouled spots with water.</p>

 <p><b>DANGER</b></p>	<p>You should be always sure that the number of people on board never exceeds that specified in the owner's manual or on the builder's plate provided on the transom.</p> <p>The boat will retain an adequate floatability and will not keel over only provided that the load is arranged reasonably. <b>Therefore, do not accommodate all passengers on the same side of the boat.</b></p>
 <p><b>DANGER</b></p>	<p>All passengers should be accommodated inside the boat. The occupied seats should not be left throughout the entire sailing time.</p>
 <p><b>DANGER</b></p>	<p>All passengers should put on life-saving jackets.</p> <p><b>CHILDREN and non-swimmers MUST WEAR A FLOATATION DEVICE AT ALL TIMES.</b></p> <p>Always check that floatation devices for children are of the right size and that they are operational.</p>
 <p><b>DANGER</b></p>	<p>Arrange the cargo to be carried uniformly inside the boat, all items being reliable secured on the bottom of the boat.</p> <p>When sailing with an outboard engine the steersman should shift his body forward in the course of acceleration to prevent the boat forebody from raising under the force of upthrust waves.</p>
 <p><b>WARNING</b></p>	<p>Despite the strong shell of the boat we recommend carefully handle and operate with sharp and pricking objects which you have on board . It concerns, for example, a knife blade, fish-hook point, etc.</p>





Approaching to rocky shores, shoals, moles, etc. , please be careful to avoid damages of your boat. It is strictly prohibited to drag the boat across rough surfaces (shingle, rocks, concrete, etc.).

In case of prolonged navigation with the use of an outboard motor, regularly check, that the motor is reliably attached to the boat. If the engine was attached carelessly, the attachment may loosen under the action of vibration.



Besides, at regular intervals, please check air chambers pressure , since the pressure may vary under the effects of outside air temperature and atmospheric pressure variations.

Never forget to monitor regularly the quantity of fuel in the fuel tank. Keep always in mind that the quantity of fuel should be sufficient for you to sail to your final destination.

#### ● Towing



At towing the towing rope length should not be less at least 3 lengths of the boat.

The steersman of the towed boat should be assisted by another crew member to monitor the process of towing. In this case, certain communication gestures should be agreed upon beforehand.



The rope have to be attached to both boats in a manner ensuring its immediately, single-motion release.

#### ● Damage to one of air chambers

The inflatable boat is designed to provide an adequate stability in case of the complete damage to one of the air chambers (balloon compartments) at the expense of the remaining air chambers and the hull. Thanks to it, you will be able to reach safely the nearest shore. Reduce the speed and shift your body to the undamaged part of the boat. Observe changes in stability. After that, immediately head for the nearest shore. To prevent penetration of water into the boat, pull the shell of the damaged air chambers upwards.

- **Mooring fast fastening**



Attach towing rope in the bow of the boat to the one of the frontal towing rings. Attach bow mooring ropes to the bow mooring cleats only. Attach rear mooring ropes or the rope of back anchor to the rear mooring cleats only.

- **Danger of currents and wind**



Before begin navigation on the boat, make detail inquiries about local conditions and regulations! Currents, wind, shoals, rising and falling tides, as well as weather variations may imply serious danger!

- **In emergency stay in boat**

In any unexpected situation (engine failure, boat damage, etc.), never leave the boat, if it is still afloat. Even if you believe that the shore is just nearby, stay in the boat, since you will be looked for in this particular place and, most probably, will be found. Should the boat become partially flooded, throw heavy objects (batteries, fuel tank, engine) overboard to ensure additional floatability.

- **Handling under power**

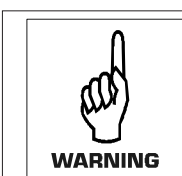

**Manoeuvrability above 30knots (55 km/h) is limited. Sudden turn may cause loss of control. Reduce speed before sharp turn, in either direction.**



**When the boat is fitted with an engine with maximum recommended power it must be use with extreme care.  
This application is directed at experienced users using their boats for very specific purposes.**



Do not operate your boat with an engine of rated power larger than that stated on the builder's plate in the boat.



Do not operate this craft at negative propulsion unit trim settings (bow down) at high speed. Craft may lean over on side. Instability in turns may result. Use negative trim to accelerate to planing speed from displacement speed and at lower planing speeds in choppy water (applicable to craft equipped with propulsion unit power trim).



Do not operate at maximum speed while in congested high traffic waterways or in weather and sea conditions of reduced visibility high winds or large waves. Reduce speed and wake as a courtesy and as a safety consideration to yourself and others. Observe and obey speed limit and no wake zones.

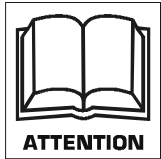

Observe right-of-way as defined by Rules of the Road and required by COLREG.

Always be certain to have sufficient distance to stop or manoeuvre if required to avoid collisions.



MODEL

**N700**

SERIAL No.

**UA-QRK**

Date of manufacture

Quality inspection stamp

**NOTE: The inflatable boat was delivered with the following equipment installed:**

1.Fuel tank	Stamp and signature	5.Shower kit	Stamp and signature
2.Electric system	Stamp and signature	6.Steering system	Stamp and signature
3.Drain system	Stamp and signature	7.Engine power system	Stamp and signature
4.Bilge pump	Stamp and signature	8.Engine installation, test and completion of plants and fittings done by	Stamp and signature